

# MIPRO®

## User Guide

### MT-90A / MT-92A

### Wireless Interlinking Transmitter

**MIPRO®**  
MICROPHONE PROFESSIONALS

**MIPRO Electronics Co., Ltd**

Headquarters : 814 Pei-Kang Road, Chiayi, 60096, Taiwan  
Tel : +886.5.238.0809 Fax : +886.5.238.0803  
www.mipro.com.tw mipro@mipro.com.tw

All rights reserved. MN 014/08  
Do not copy or forward without prior approvals MIPRO.  
Specifications and design subject to change without notice.



2 CE 4 4 1 B





## **! IMPORTANT SAFETY INSTRUCTIONS !**

1. Read these instructions.
2. Keep these instructions.
3. Heed all warnings.
4. Follow all instructions.
5. Do not use this apparatus near water.
6. Clean only with a dry cloth.
7. Do not block any ventilation openings. Install in accordance with the manufacturer's instructions.
8. Do not install near any heat sources such as radiators, heat registers, stoves, or other apparatus (including amplifiers) that produce heat.
9. Do not defeat the safety purpose of the polarised or ground plug: A polarised plug has two blades with one wider than the other. The wide blade is provided for your safety. When the provided plug does not fit into your outlet, consult an electrician for replacement of the obsolete outlet.
10. Protect the power cord from being walked on or pinched particularly at plug, convenience receptacles, and the point where they exit from the apparatus.
11. Only use attachments/accessories specified by the manufacturer.
12. Use only with a cart, stand, tripod, bracket, or table specified by the manufacturer, or sold with the apparatus. When a cart is used, use caution when moving the cart/apparatus combination to avoid injury from tip-over. 
13. Unplug this apparatus during lightning storms or when unused for long periods of time.
14. Refer all servicing to qualified service personnel. Servicing is required when the apparatus has been damaged in any way, such as power-supply cord or plug is damaged, liquid has been spilled or objects have fallen into the apparatus, the apparatus has been exposed to rain or moisture, does not operate normally, or has been dropped.
15. To reduce the risk of fire or electric shock, do not expose this apparatus to rain or moisture.
16. Apparatus should not be exposed to dripping or splashing and no objects filled with liquids, should be placed on the apparatus.
17. Use only with the battery which specified by manufacturer.
18. The power supply cord set is to be the main disconnected device.

## **WARNING**

1. **FOR OUTDOOR USE:**  
To reduce the risk of fire or electric shock, do not expose this apparatus to rain or moisture.
2. **UNDER WET LOCATION:**  
Apparatus should not be exposed to dripping or splashing and no objects filled with liquids, such as vases should be placed on the apparatus.
3. **SERVICE INSTRUCTIONS:**  
CAUTION - These servicing instructions are for use by qualified service personnel only. To reduce the risk of electric shock, do not perform any servicing other than that contained in the operating instructions unless you are qualified to do so.

	
	This symbol indicates that dangerous voltage constituting a risk of electric shock is present within this unit.
	This symbol indicates that there are important operating and maintenance instructions in the literature accompanying this unit.

**Disposal** Dispose of any unusable devices or batteries responsibly and in accordance with any applicable regulations.



2006-08-15

Disposing of used batteries with domestic waste is to be avoided!

Batteries / NiCad cells often contain heavy metals such as cadmium(Cd), mercury(Hg) and lead(Pb) that makes them unsuitable for disposal with domestic waste. You may return spent batteries/accumulators free of charge to recycling centres or anywhere else batteries/accumulators are sold.

By doing so, you contribute to the conservation of our environment!

THIS DEVICE COMPLIES WITH PART74 OF THE FCC RULES. This equipment complies with FCC RF radiation exposure limits set forth for an uncontrolled environment.

## **IC**

This device complies with Industry Canada licence-exempt RSS-123 Issue2 standard.

Operation is subject to the following two conditions:

- (1) this device may not cause interference, and
- (2) this device must accept any interference, including interference that may cause undesired operation of the device.

Le présent appareil est conforme aux CNR d'Industrie Canada applicables aux appareils radio exempts de licence. L'exploitation est autorisée aux deux conditions suivantes:

- (1) l'appareil ne doit pas produire de brouillage, et
- (2) l'utilisateur de l'appareil doit accepter tout brouillage radioélectrique subi, même si le brouillage est susceptible d'en compromettre le fonctionnement.

## **Contents**

- 2 Controls and Indicators - Front Panel
- 3 Controls and Indicators - Rear Panel
- 4 Controls and Indicators
- 5 Transmitter Frequency Set-Up
- 6 Operating Tips
- 7 Insert and Remove the Module
- 8 Proper RF Output Level and Output Connector Settings
- 9 Proper AF (audio) Input and Connection
- 10 Optimal AF Input Volume Setting
- 11 Selection of Transmitting Antenna AF Input Volume Setting

## System Accessories Included:

Antenna ×1



User Guide ×1



## Controls and Indicators

### Front Panel

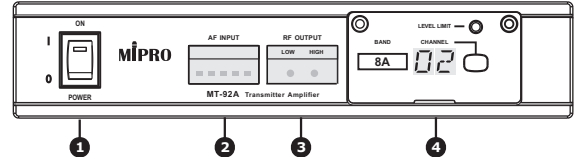

- ❶ **Power Switch & Indicator:** Red indicator is illuminated after power is turned on.
- ❷ **AF Signal Indicators:** Indicate the input audio signal level.
- ❸ **RF Signal Indicators:** Indicate the output RF signal level.
- ❹ **Transmitter Module:** Plug-in module preset with 16 selectable channels.

### Notes

1. Refer to actual product in the event of product description discrepancy.
2. Frequency range and maximum deviation comply with the regulations of different countries.

## Controls and Indicators

### Rear Panel

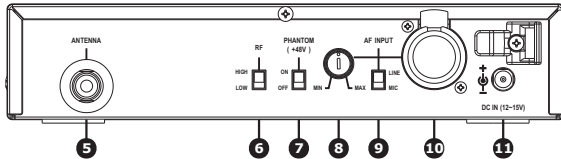

- 5 RF Output Connector:** Connect directly to a transmitting antenna or extend to external antenna by RF cable.
- 6 RF Output Switch:** High or Low RF level switch.
- 7 +48V Phantom Power Switch:** Can be switched to offer +48V Phantom power to wired microphones or not.
- 8 AF Level Knob:** Adjust to select the optimal sensitivity without distortion.
- 9 AF Level Switch:** MIC LEVEL(0dB) and LINE LEVEL(-20dB) audio output for optimal modulation index.
- 10 Combo Jack Connector:** Balanced (XLR) or unbalanced (1/4-inch) audio input signals.
- 11 DC Voltage Input Connector:** 12~15V DC voltage, the center pole of the DC connector is positive voltage.

## Controls and Indicators

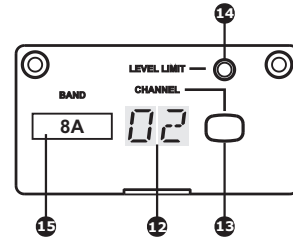

- 12 LED screen:** Displays current numeric channel.
- 13 Channel button**
- 14 Volume Limiter Indicator**
- 15 Frequency Code Sticker:** The code identifies the contained frequency range.

## Transmitter Frequency Set-Up

- Press and hold Channel button **13** for 2 seconds until numeric LED blinks continuously to denote it is ready for changing channel.
- During blinking, press and release the Channel button until one of the 16 preset channels is selected.
- If Channel button is not pressed within 6 seconds during blinking the current numeric channel remains the same.
- Volume Limit Indicator **14** will not be illuminated under normal input signals.
- Volume Limiter Indicator **14** will be illuminated if over normal input signals. Reduce volume to desired level.

## Operating Tips

- The transmitter functions when the module and antenna are inserted properly and powered on. Ascertain the frequency code sticker is the same between the transmitter and receiver.
- Select another module with a different frequency code if the existing operating frequency experiences continuous interference.
- Module is available in frequency codes between 620~934MHz and compatible with MIPRO wireless receivers or portable PA amplifiers with the same frequency codes.

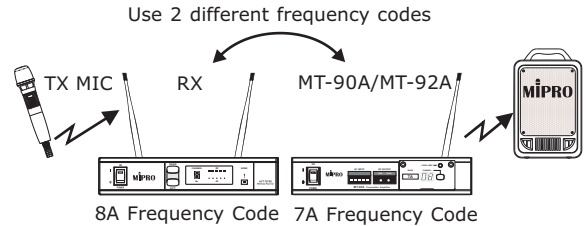

## Insert and Remove the Module

- Remove the front cover plate.
- Insert MT-90/MT-92 module gently into slot horizontally.
- Fasten the panel with the attached two screws.
- To remove, reverse the above steps.

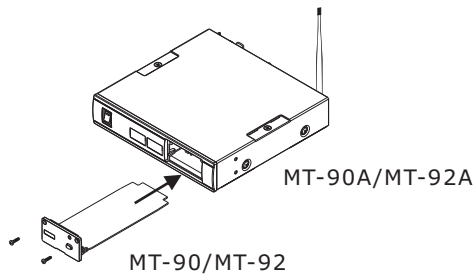

## Proper RF Output Level and Output Connector Settings

- High or Low RF level switch is located at the rear panel. Front panel will display current High or Low RF output power setting.

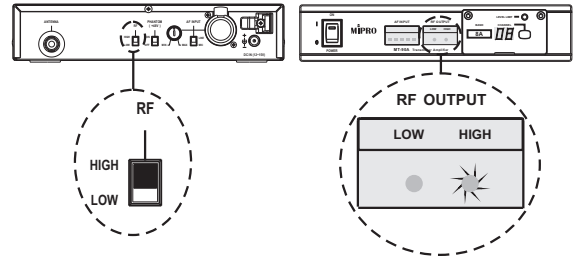

## +48V Phantom Power Setting

- +48V Phantom Power is available from the combo jack connector. Use the +48V Phantom Power Switch at the rear panel to activate this function.

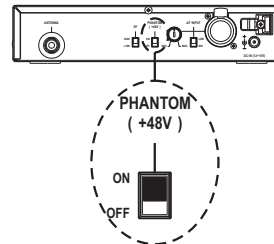

## Proper AF (audio) Input and Connection

- Combo jack connector accepts balanced (XLR) or 1/4-inch(6.3mm) unbalanced cable.
- Proper input volume adjustment is needed after AF signal is connected.
- Two selectable AF levels (MIC/LINE) can be selected from AF Level Switch ⑨ for optimal audio sensitivity. Exceeding input volume will result in distortion for receiver AF output, and insufficient input volume will degrade the S/N ratio that increases higher background noise. RF, proper setting ensures optimal output audio quality.

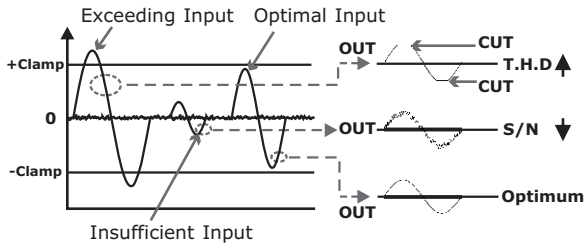

## Optimal AF Input Volume Setting

- The AF Signal Indicators ② indicates the input audio signal level.
- Normal volume: 2~3 LEDs are illuminated.
- High volume: 4 LEDs are illuminated.
- Peak volume: Red Limit indicator will be illuminated to denote warning.

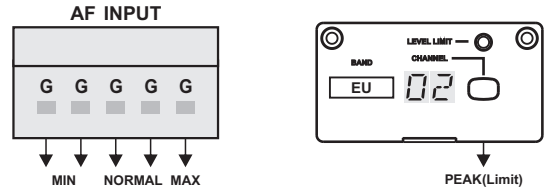

- When 4~5 LEDs are illuminated constantly it denotes exceeding input volume and input attenuation is required. Switch the input volume switch ⑨ to -20dB or adjust the AF Level Knob ⑧ counterclockwise for modification.

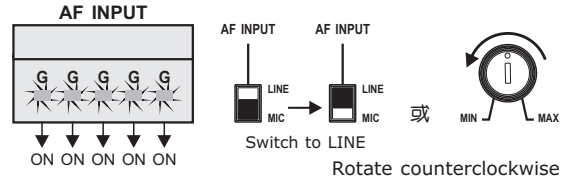

- When 1~2 LEDs are illuminated constantly it denotes insufficient input volume and less input attenuation is required. Switch the input volume switch ⑨ to 0dB or adjust the AF Level Knob ⑧ clockwise for modification.

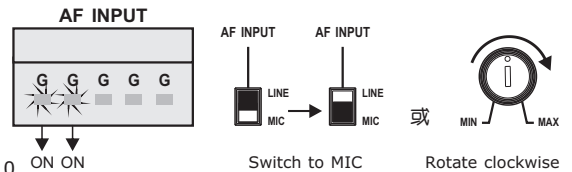

## Selection of Transmitting Antenna AF Input Volume Setting

- MIPRO UHF antennas such as non-directional  $1/4 \lambda$  antenna,  $1/2 \lambda$  antenna, AT-90 or AT-90W or AT-100 wideband directional antenna can be selected as the transmitting antenna to increase transmitting range.
- The use of AT-90 or AT-90W or AT-100 wideband directional antenna connected with  $50 \Omega$  coaxial cable provides higher transmission efficiency for the system.

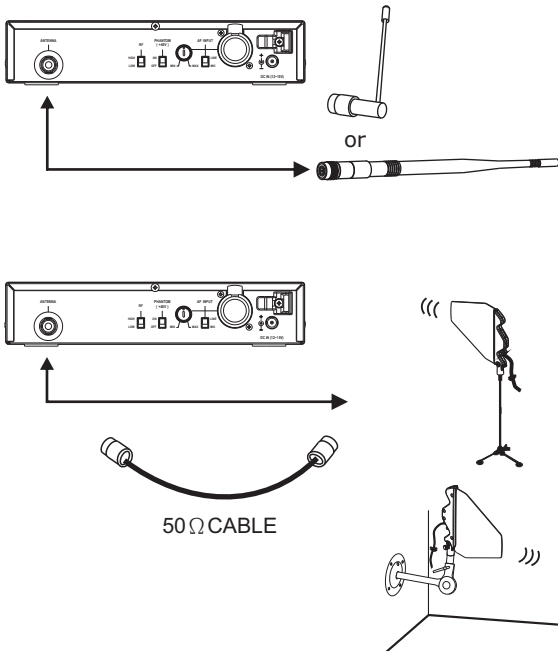

- MIPRO AD-90S, high-powered splitter, or AD-90A, high-powered amplifier, can be installed to greatly increase transmitting range and coverage to reduce signal dropouts.

